

---

Monteringsanvisning / Installation instruction

FMM: 100 98 60 - Rev.000

## **Byte sensor duo**

### **Change sensor duo**

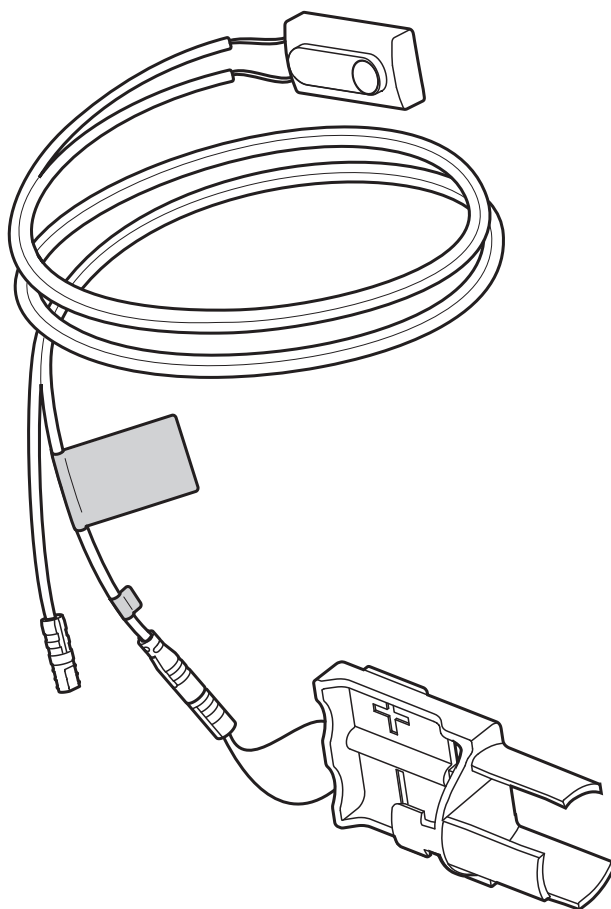

## SV

1. Ta ur batteriet ur batterihållaren. Lossa sensorns kontaktledningar till batterihållare och magnetventil under diskbänken. Knipsa av ev buntband som fixerar kablarna.
2. Lossa blandaren genom att lossa fästmuttrarna under diskbänken [a] och dra upp blandaren [b].

1

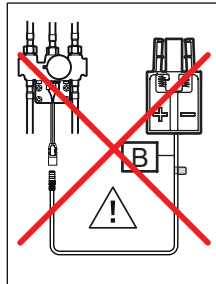
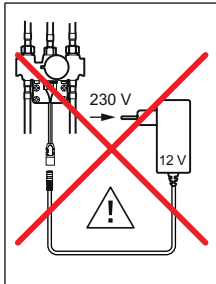
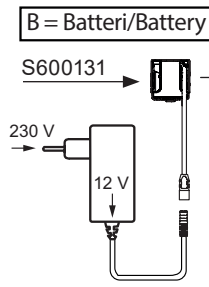
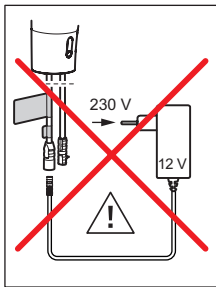
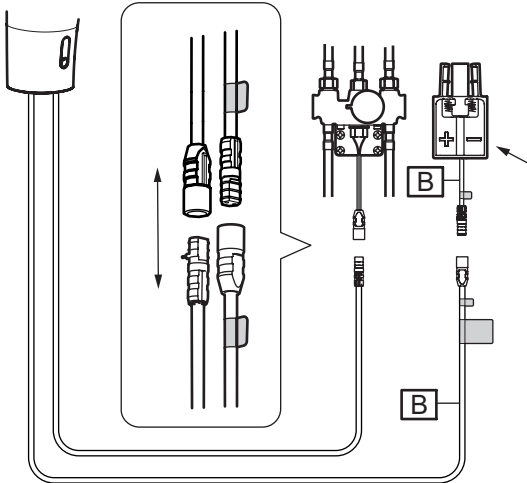

## EN

1. Remove the battery from the battery holder. Disengage the sensor connectors and solenoid valve under the sink. Snip off any cable ties.
2. Remove the retaining nut under the sink and pull the mixer up.

2

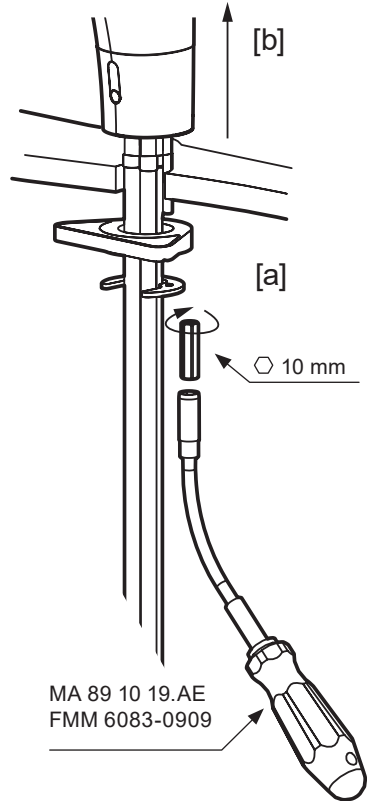

## SV

3. Lossa fästskruvarna
4. Dela blandaren lika som på bilden, så att sensors hållare blir synlig.

3

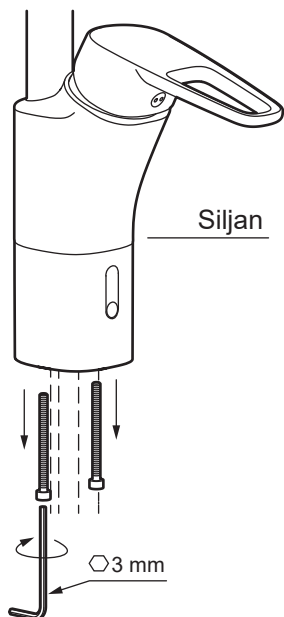

## EN

3. Loosen the set screws
4. Divide the mixer, as shown, so that the sensor holder is visible.

4

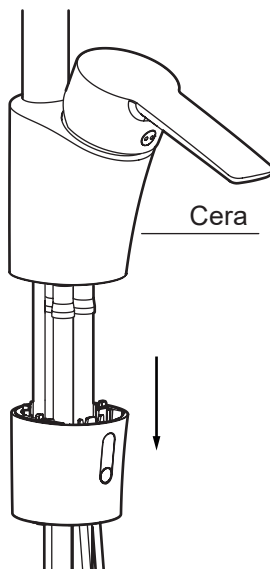
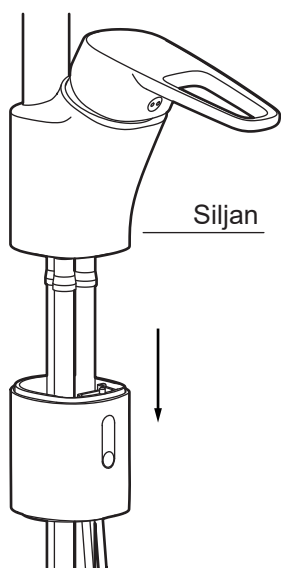

## SV

5. Dra upp kablarna så att de tillåter att sensorhållaren kan dras upp ur sitt läge.
6. Dra upp sensorhållaren.
7. Peta in sensorn i blandarfoten, sensorn kan därefter dras ur tillsammans med kablarna.
8. Montera ihop med ny sensor i omvänd ordning utan att sätta i batteri.
9. Som sista steg, starta upp blandaren genom att ansluta batteri/strömkälla. En 5 sek lång uppstartssekvens inleds, sensorn kalibreras och blinkar med gult sken. Undvik rörelse framför sensorn under denna sekvens. Blinkar sensorn rött, ta ur batteriet och kontrollera anslutningen till magnetventilen. Starta ny sekvens genom att på nytt ansluta batteriet.
10. Blandaren klar att användas när sensorn har slutat blinka.

## EN

5. Pull the cables up, so that the sensor holder could be dismantled from its position.
6. Pull up the sensor container.
7. Push the sensor into the mixers bottom part and then pull it out together with the cables.
8. Assemble with new sensor in reverse order without inserting battery.
9. As a last step, start up the mixer by connecting the battery/power source. A 5 sec start-up sequence begins, the sensor is calibrated and flashes amber. Avoid movement in front of the sensor during this sequence. If the sensor flashes red, remove the battery and check the connection to the solenoid valve. Start a new sequence by reconnecting the battery.
10. The mixer is ready for use when the sensor has stopped flashing.

