



9000XE rinse mixer

Designed to meet the demanding requirements of professional kitchens, this mixer combines a sleek, durable design with materials that are easy to clean and keep hygienic. It is completely lead-free and equipped with easy-grip handles as well as a built-in diverter function that makes it simple to switch between the spout and the flexible spray nozzle.

The mixer responds quickly to changes in pressure and temperature, ensuring a consistent and safe water temperature. The automatic hot-water lock also provides complete scald protection. Delivered with a 10-year 9000XE functional guarantee for extra peace of mind in everyday use.

Article number: 86655000 **RSK:** 8410019 **Flow 3 bar:** 16.0 l/m

Description: Chrome, 160 c/c

Unique characteristics



Backflow protection unit type 

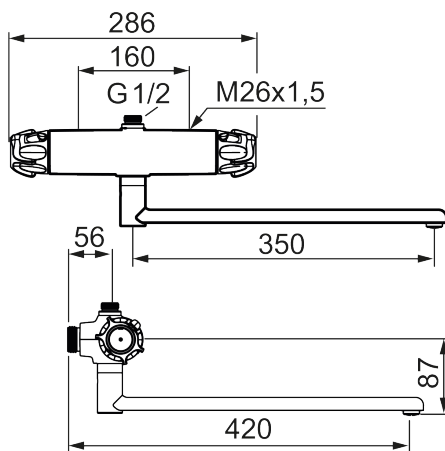

- Pressure balanced thermostatic mixer
- Temperature handle with safety stop 38°C
- With Eco-function
- Lead Free material
- With approved non-return valves, EN-Standard EN1717
- With swivel spout, length 350 mm
- With care-handle

PRODUCT DESCRIPTION

9000XE rinse mixer

Designed to meet the demanding requirements of professional kitchens, this mixer combines a sleek, durable design with materials that are easy to clean and keep hygienic. It is completely lead-free and equipped with easy-grip handles as well as a built-in diverter function that makes it simple to switch between the spout and the flexible spray nozzle.

The mixer responds quickly to changes in pressure and temperature, ensuring a consistent and safe water temperature. The automatic hot-water lock also provides complete scald protection. Delivered with a 10-year 9000XE functional guarantee for extra peace of mind in everyday use.

Article number: 86655000 RSK: 8410019

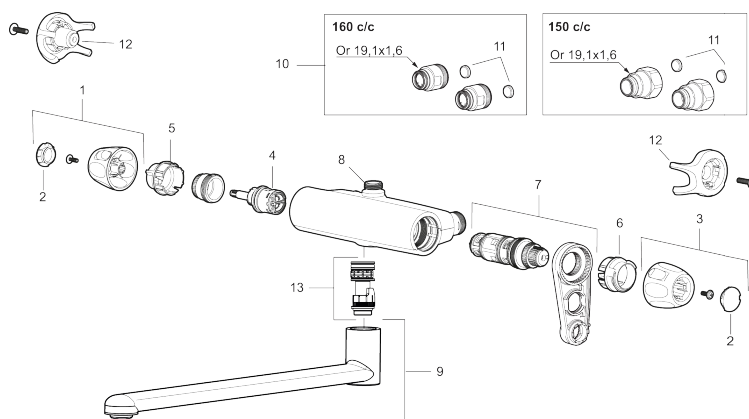

Sparepartlist

NO.	FMM NO.	RSK	DESCRIPTION
1	S600083	8218917	On/off handle, complete, krom
2	S600116	8218920	End cover, chrome
3	S600082	8218914	Temperature handle, complete, chrome
4	S600021	8441463	Reversible headwork 22 l/min, with service tool
4	S600270	8387233	Reversible headwork 22 l/min
5	S600117	8439714	Stop ring, for two outlet (down and up)
6	S600087	8439711	Scalding protection ring, max 50°C
7	S600084	8439709	Thermostatic cartridge, complete, incl. service tool
7	S600271	8397030	Thermostatic cartridge, complete, without service tool
8	S600088	8439712	Nipple M18x1-G1/2 for shower mixer
9	35861350	8242308	Spout, L=350 mm, 11-15 l/min at 300 kPa
10	59800800	8592005	Inlet connectors, 160 c/c

NO.	FMM NO.	RSK	DESCRIPTION
11	38632006	8590311	Filter
12	S600105	8439713	Care-handle, black, 2 pcs
13	S600374	8920762	Spout nipple, complete