

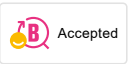

Unique characteristics

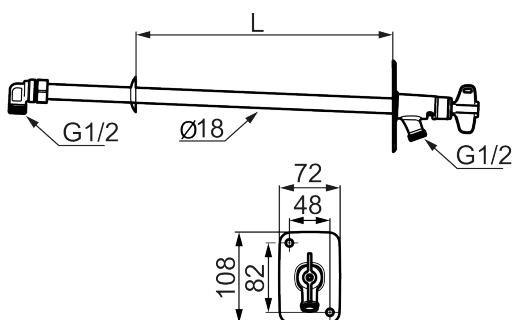

Backflow protection unit type **HD**



Garden valve with key

FM Mattsson's outdoor tap is the next step in the development of safe and smart outdoor installations – designed and manufactured in Mora, Sweden. Here, functionality and reliability come together in a well-thought-out design developed in close collaboration with installers.

It is designed with an integrated vacuum valve and features a self-draining function that automatically drains the water when the tap is turned off. In winter, quick coupling and hose must always be removed to prevent frost damage. A reliable backflow protection also prevents contaminated water from flowing back into the system during sudden pressure changes – an extra level of safety for both homes and properties.

The outdoor tap is made from lead-free materials and is future-proofed for long, trouble-free operation.

A new generation of outdoor taps – developed for professionals, together with professionals – designed so that everyone can feel confident in their installation.

Article number: 42960400 **RSK:** 4315004

Description: For wall thickness max. 400 mm

- Self-draining and therefore frost-safe
- Integrated vacuum valve
- Can be cut to adapt to wall thickness
- Key can be attached to the outdoor tap
- Wall plate: Height 108 mm, width 72 mm, diagonal screw holes
- Backflow protection
- Lead-free
- Self-draining with hose
- Type-approved according to standard EN1717